

# Operation Instruction

## M-238G Non-contact switch for special room

Make your choice.....



### 1 safety instruction

**!** This device must use a low voltage with protected safety insulation, all commissioning and repair work must be installed by a professional engineering installer

### 2 Reference occasions and overall product characteristics

- This product is mainly used for limited personnel occasion.
  - This special room switch use large panel setting, laser carving technology, exquisite and high-grade
  - Equipped with HD voice system (Chinese, English, Cantonese optional and customized voice)
  - Both the inner and outer panels have text light instructions, and the panels clearly identify the use steps for easy operation.
  - This product is equipped with service time remind function
- Be used for airports, subway stations, stations, large shopping malls, etc.

### 3 overview of product

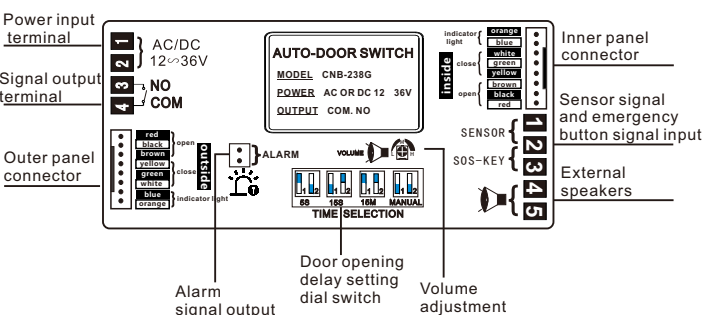
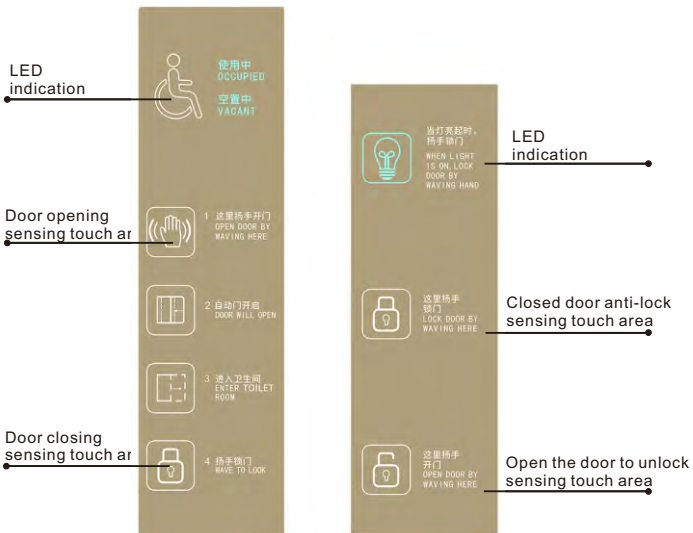

### 4 Mounting hole size chart

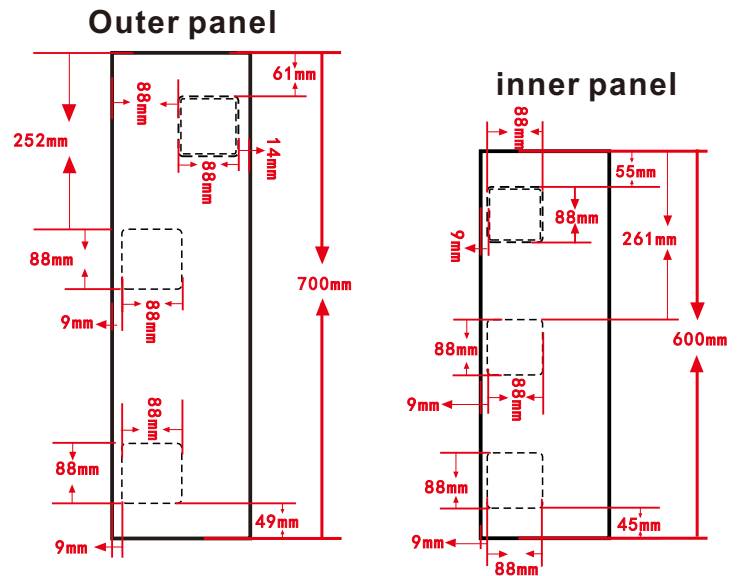

### 5 outer&inner panel wiring

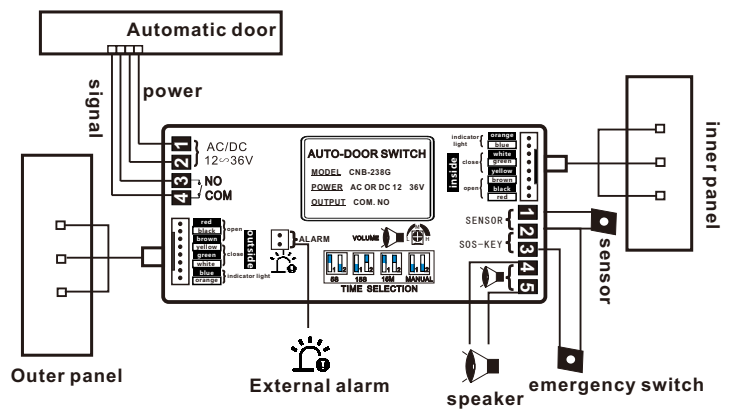

1. Take the 12-36V power from the automatic door to the controller and connect the signal output to the automatic door signal terminal
2. The inner and outer panel wiring are the same. Red, black, brown => Door opening sensing touch switch. Yellow, green, white => Door closing sensor touch switch. Blue, orange => LED indicator
3. sensor: After entering the anti-lock state, if no signal is detected for 5 minutes, the door will be unlocked and the alarm signal will be output. Press any door close button to cancel the alarm. If you do not connect the sensor, short it up.
4. emergency switch: Requires hold-type switch, when the emergency switch is pressed, the door is unlocked and an alarm signal is issued
5. Alarm: Output is relay contact signal
6. External speaker: 4-8Ω, 1-5W speaker

### 6 Door open hold time adjustment

- 【 1 】** Adjust the position of the speaker volume, clockwise adjust for high volume, counterclockwise to adjust for low volume

**【 2 】 Dial switch setting**

ON	1 2	1 2	1 2	1 2
TIME	5S	15S	15mins	manually

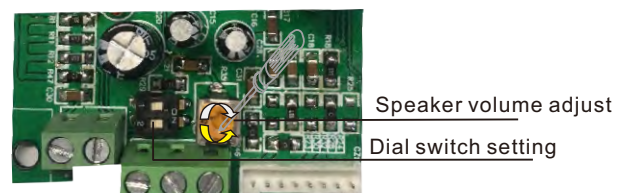

## 7 operation

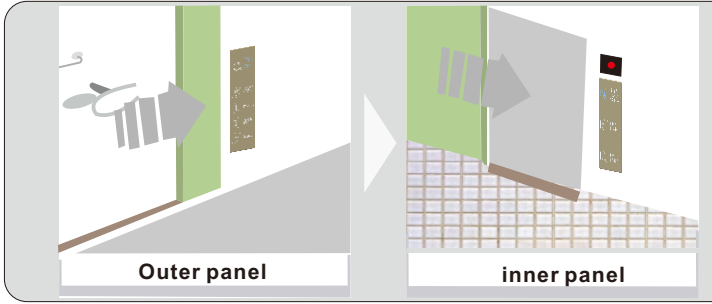

【 1 】on standby mode, "vacant"indicator on outer panel lights, The inner panel indicator is on

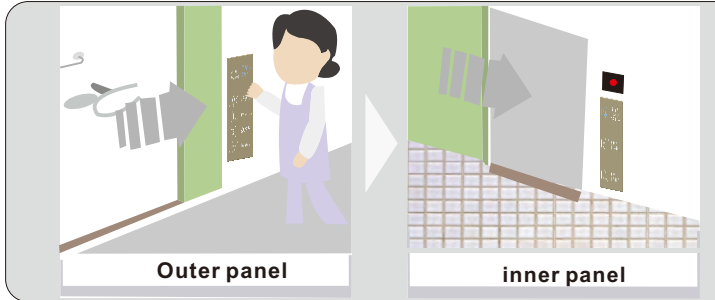

【 2 】wave hands to the door open button on the outer panel, and the automatic door open. At the same time, there is a voice prompt "door is opening".

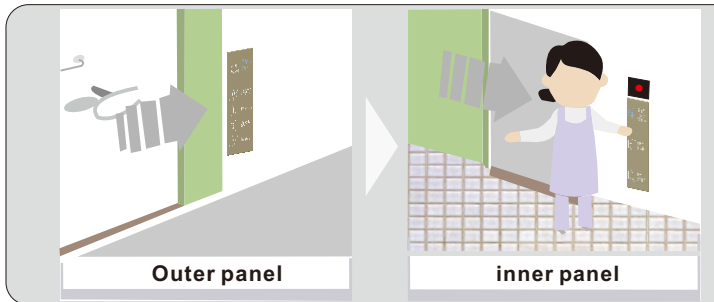

【 3 】After entering the room, wave hands to the door close button, the door automatically close and lock. At the same time, there will be a voice prompt "door is closing". If the door is not closed for more than five seconds, there will be a voice prompt "please lock the door"

【 4 】After door is locked, the "OCCUPIED" indicator light on the outer panel is on, and the indicator light on the inner panel is off. At this time,if someone wave hands to the door open or close button on the outer panel will issue a "occupied" voice prompt and the door will not be opened.

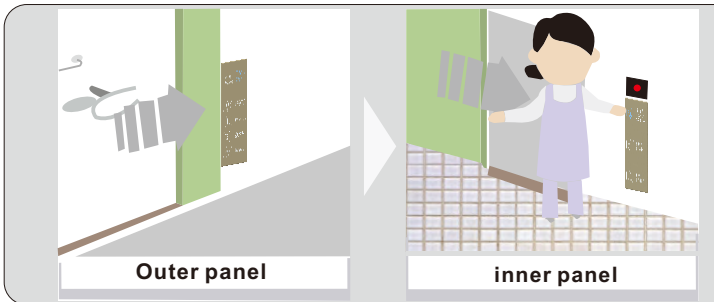

【 5 】When the people inside need go out, wave hands to door open button, the door will open and there will be a voice prompt "door is opening"

【 6 】When people come out, the automatic door will be closed automatically according to the setting time of the dial switch or wave hands to door close button. The automatic door will be closed immediately. At the same time, there will be a voice prompt "door is closing" and return to the standby mode.

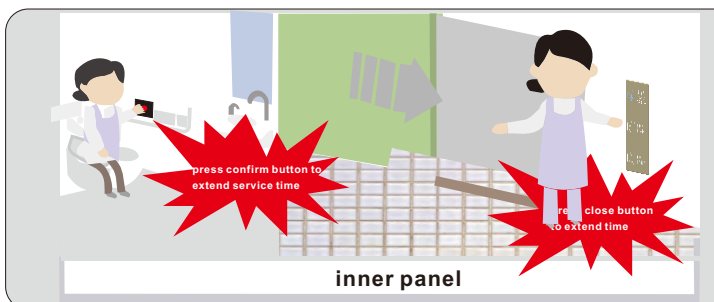

【 7 】The longest use time of this system is 30 minutes. When using it for 25 minutes, the system will voice prompt "This system will unlock the anti-lock function in five minutes. If you need to continue to use, please press the confirmation button, thank you" otherwise the system will be in five minutes Automatic unlocking

## 8 Special operation

### ■ Emergency opening

When the controller is in use, if there is an accident or special circumstances need to open the door, you can sense the door close button,at the same time,Continuous sensing the door open button five times within ten seconds, and the voice prompt " door is opening" door will open and then the system returns to standby mode

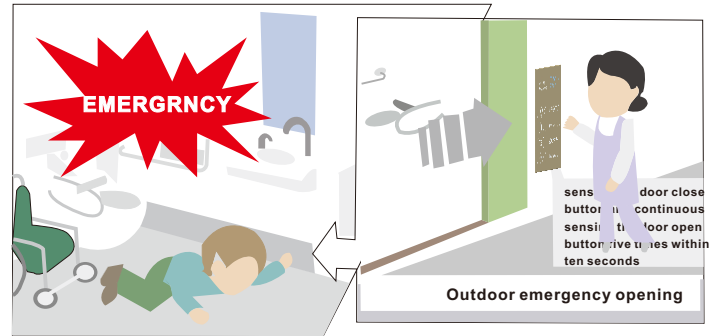

### ■ Emergency lock

When paused, you can sense the door open button,at the same time,continuous sensing the door close button five times within ten seconds,The voice prompt "door is closing" system is in use, but the inner panel does not work. (If you want to unlock, perform an emergency opening)

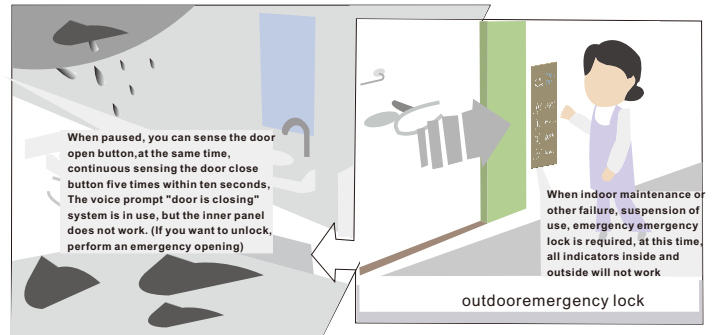

## 9 Sensitivity setting

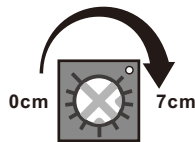

The clockwise direction the induction distance becomes farther, the counterclockwise direction the induction distance becomes closer, and the maximum induction distance is 7cm. Note: the adjustment button is on the back of the faceplate

## 10 parameter

working voltage	AC/DC 12V 36V
standby current	125mA(12Vpower)
action current	165mA (12Vpower)
voice	English, Chinese, Cantonese (can be customized)
output	Relay dry contact
Door open hold time	5S、15S、15M、Manually
Inner panel size	600mm (L) × 200mm (W) × 15mm (H)
Outer panel size	700mm (L) × 200mm (W) × 15mm (H)
Main controller size	145mm (L) × 57mm (W) × 38mm (H)